

QUILT RULER CONNECTOR™

Easily and Accurately Align and Connect Two Quilt Rulers.

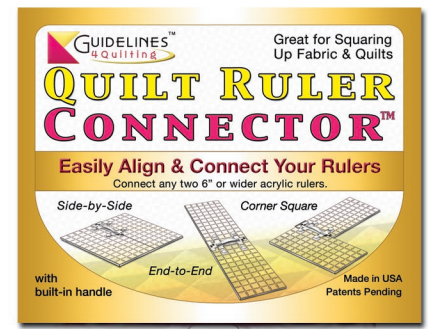

Side-by-Side

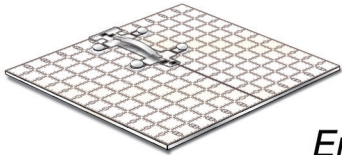

End-to-End

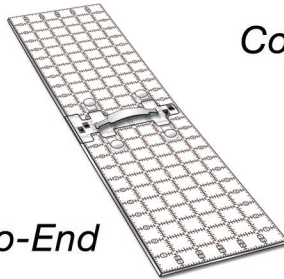

Corner Square

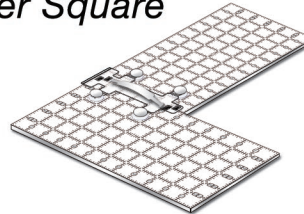

Forget lugging a big 24" ruler to class. Simply take two 12" rulers and the Quilt Ruler Connector™ by Guidelines4Quilting™, and turn them into a 24" long or a 12" square ruler.



Made in the USA



GUIDELINES™
4 Quilting

www.Guidelines4Quilting.com

Square up Fabric in an Easy Way:

1) Connect a 12" & 24" rulers as a corner square.

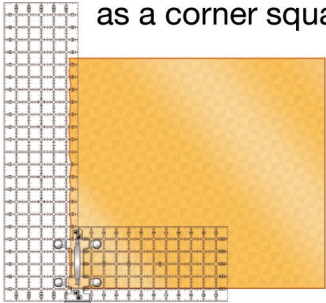

Then, align the folded edge of the fabric to a line on the 12" ruler.

2) Remove the 12" Ruler and the Connector.

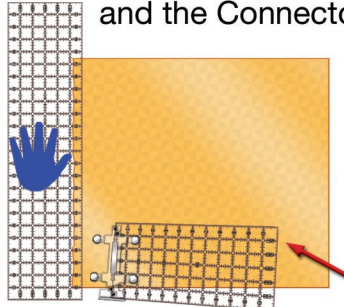

Square up the edge and start cutting strips from the same side of the fabric.

Make a 3-Foot Ruler with your 12" and 24" rulers & cut Bias Binding Strips.

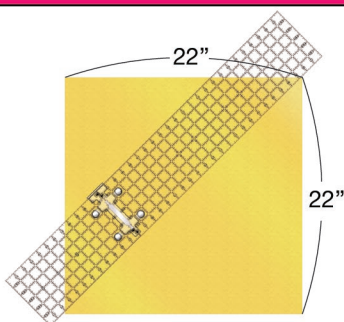

- For right or left-handed use.
- Patent Pending Black Alignment Tabs and Lip Edge ensure easy, accurate connection every time.
- Made of super tough polycarbonate, it is virtually unbreakable.
- Made in USA

Example Combinations that You Can Make:

